

## TX2 CRAWLER ADAPTER TOYOTA 4WD TRUCKS 23T INPUT

### KIT CONSISTS OF:

No.	Qty	Part No.	Description
1.	1	51-5909	TX2 ADAPTER CASTING
2.	1	52-5910	DOUBLE BEARING COUPLER
3.	11	716065	10mm X 1.25" X 48mm SPECIAL STUD
4.	2	716182	THRUST BUSHING
5.	1	716182B	1/4" BALL
6.	2	716308	ROLLER BEARING
7.	1	716323	NEEDLE BEARING FOR CLUSTER GEAR
8.	1	716456	SNAP RING (T/A #N5000-334)
9.	1	716463	SNAP RING
10.	1	716563	GASKET
11.	1	716564	GASKET
12.	11	720012	10mm X 1.25" NUT
13.	11	720015	10mm FLATWASHERS
14.	11	720038	10mm LOCKWASHERS
15.	1	911069	KEY STOCK

### OPTIONAL ITEM:

We offer a custom 12" speedometer extension for the crawler boxes. This extension comes with both size drive cogs to fit your stock or replacement transfer case P/N 716186-C.



### Suggested Tools

Ratchet with a 12MM, 14MM, & 30MM sockets  
Needle nose pliers  
Snap ring pliers  
6MM allen wrenches  
Hammer  
3/16" punch  
Straight screw driver  
Crescent wrench  
Loctite  
Assembly lube

### PREPARATION OF THE GEAR BOX

Disassemble the extra transfer case gear box using the instruction on the following pages.

**SPECIAL NOTE:** The components packaged in this kit have been assembled and machined for specific type of conversions. Modifications to any of the components will void any possible warranty or return privileges. If you do not fully understand modifications or changes that will be required to complete your conversion, we strongly recommend that you contact our sales department for more information. This instruction sheet is only to be used for the assembly of Advance Adapter components. We recommend that a service manual pertaining to your vehicle be obtained for specific torque values, wiring diagrams and other related equipment. These manuals are normally available at automotive dealerships and parts stores.

## TX2 CRAWLER ADAPTER TOYOTA 4WD TRUCKS 23T INPUT

### DISASSEMBLY PROCEDURES

The Advance Adapters TX2 crawler kit is ideal for the avid Toyota Truck rock crawler. The installation of the TX2 requires you to almost completely disassemble the donor transfer case. We have provided illustrative disassembly and assembly instructions to assist you. These instructions are to be used as a guide. The official Toyota shop manual is strongly recommended for additional information.

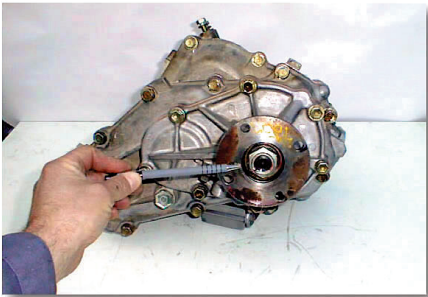

- (1) **The transfer case must be in 2WD High before starting the disassembly procedures.** Remove the nut with a 30mm socket and then remove the flange.



- (3) With the rear extension housing removed, you will see the oil pump and speedometer drive gears. Slide the gears off of the rear output shaft.

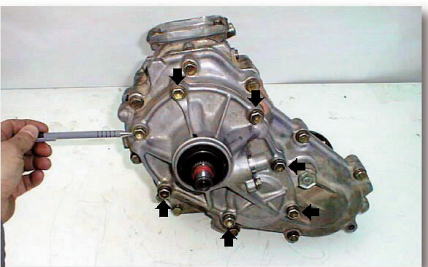

- (2) Remove the 7 bolts that retain the rear extension housing with a 14mm metric socket.

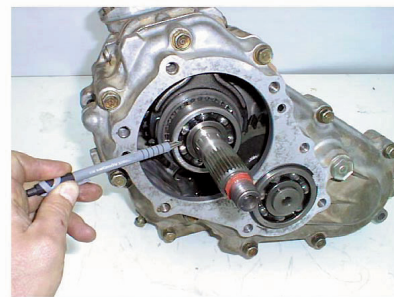

- (4) Remove the rear output shaft bearing.

**SPECIAL NOTE:** The components packaged in this kit have been assembled and machined for specific type of conversions. Modifications to any of the components will void any possible warranty or return privileges. If you do not fully understand modifications or changes that will be required to complete your conversion, we strongly recommend that you contact our sales department for more information. This instruction sheet is only to be used for the assembly of Advance Adapter components. We recommend that a service manual pertaining to your vehicle be obtained for specific torque values, wiring diagrams and other related equipment. These manuals are normally available at automotive dealerships and parts stores.

## TX2 CRAWLER ADAPTER TOYOTA 4WD TRUCKS 23T INPUT

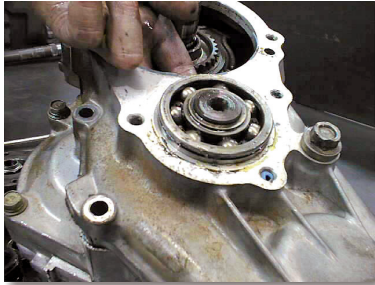

- (5) Remove outer bearing C-clip by reaching inside case and pushing up on gear, while lightly tapping on the case with a plastic soft blow mallet.



- (8) Using a 3/16" (4mm) punch, drive the roll pin out that holds the front wheel drive shift fork.

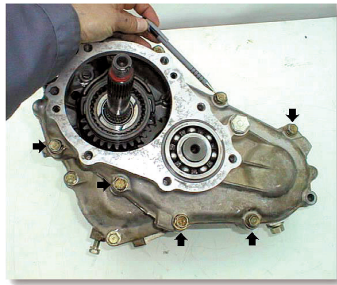

- (6) Remove the 10 bolts retaining the rear case cover with a 14mm socket.

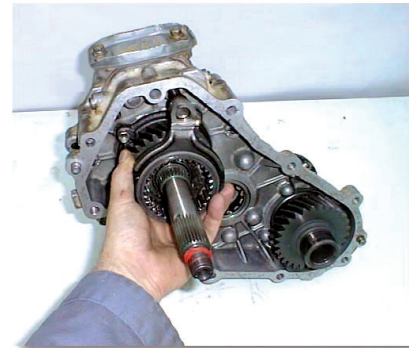

- (9) Slide the fork and clutch sleeve off the shift rail.

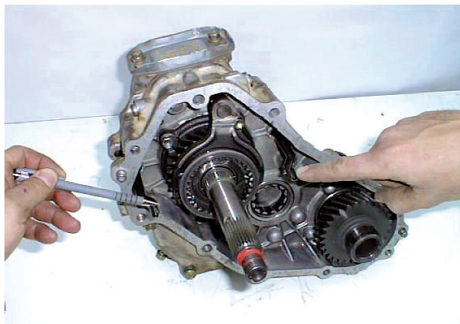

- (7) Pull case off. Remove the two lubrication tubes located on either side of the main shaft. **Note their orientation!**

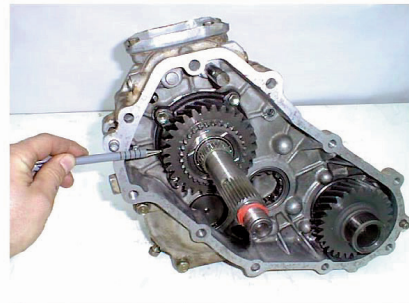

- (10) Remove the front wheel drive gear and its caged needle roller bearing assembly.

**SPECIAL NOTE:** The components packaged in this kit have been assembled and machined for specific type of conversions. Modifications to any of the components will void any possible warranty or return privileges. If you do not fully understand modifications or changes that will be required to complete your conversion, we strongly recommend that you contact our sales department for more information. This instruction sheet is only to be used for the assembly of Advance Adapter components. We recommend that a service manual pertaining to your vehicle be obtained for specific torque values, wiring diagrams and other related equipment. These manuals are normally available at automotive dealerships and parts stores.

## TX2 CRAWLER ADAPTER TOYOTA 4WD TRUCKS 23T INPUT

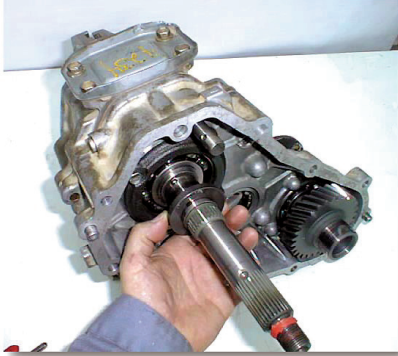

- (11) Remove the thick spacer found behind the front wheel drive gear and be aware of the small ball bearing underneath it.

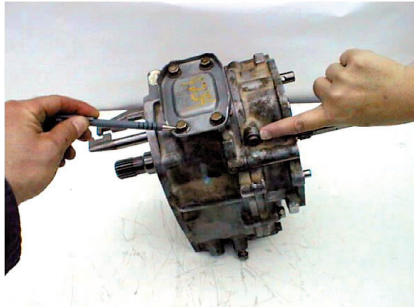

- (12) Use a 12mm socket to remove the four bolts that retain the shift fork cover. With a 6mm Allen wrench, remove the shift detent screw plugs found on both sides of the case.

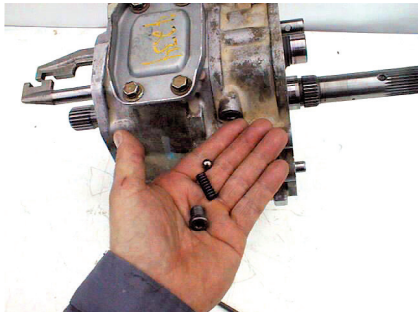

- (13) With the screw plugs removed, the shift ball and spring assemblies can be removed from both sides.

- (14) Drive the roll pin out that retains the high/low shift fork using a 3/16" (4mm) punch. Occasionally the pin will fall into the case. Don't worry. You will be able to retrieve the pin later. On 1979-83 and 1985-88 fuel injected model transfer cases, **DO NOT REMOVE** roll pin.

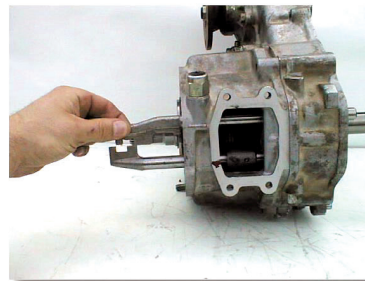
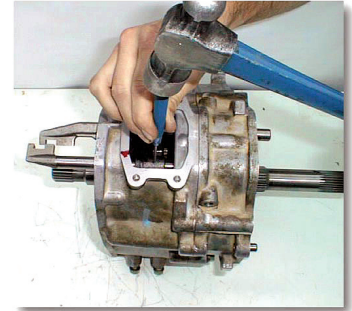

- (15) Remove the shift rails, being careful not to lose the interlock pin that might fall out.

This interlock pin is located between the two shift rail detent assembly chambers.

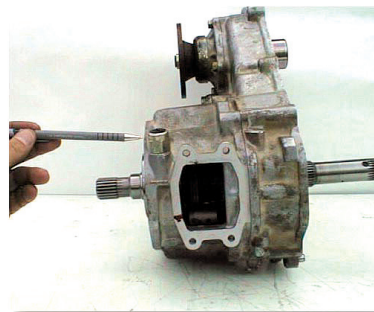
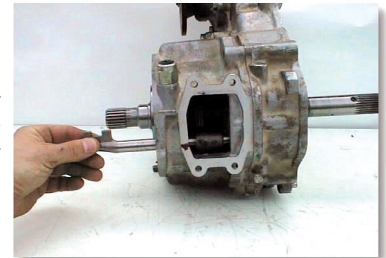

- (16) Remove the 4WD indicator switch with a 22mm or adjustable wrench.

**SPECIAL NOTE:** The components packaged in this kit have been assembled and machined for specific type of conversions. Modifications to any of the components will void any possible warranty or return privileges. If you do not fully understand modifications or changes that will be required to complete your conversion, we strongly recommend that you contact our sales department for more information. This instruction sheet is only to be used for the assembly of Advance Adapter components. We recommend that a service manual pertaining to your vehicle be obtained for specific torque values, wiring diagrams and other related equipment. These manuals are normally available at automotive dealerships and parts stores.

## TX2 CRAWLER ADAPTER TOYOTA 4WD TRUCKS 23T INPUT

(17) Remove the interlock pin from the shifter detent chamber, if you haven't already done so in Step 15.

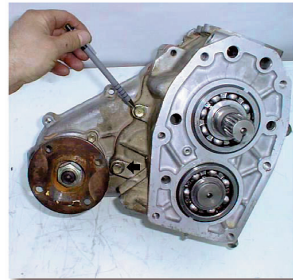
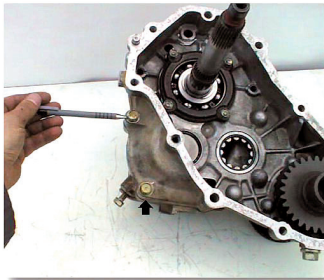
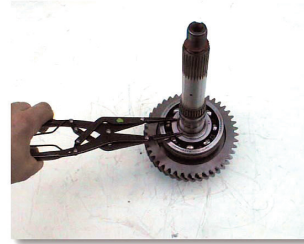
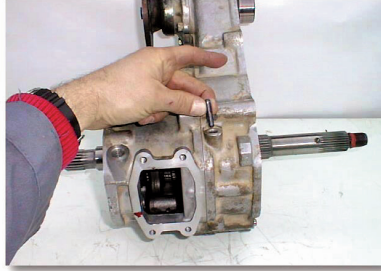

(20) Remove the low range gear by removing the snap ring that retains the roller bearing onto the rear shaft. Press the roller bearing off of the shaft.

(18) Use a 14mm socket to remove the 4 bolts that retain the front case to the reduction case. Split the cases. Now you can retrieve the roll pin that might have fallen in as noted on Step 14.

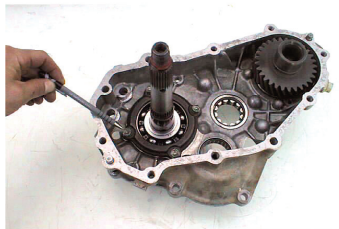

(19) Remove the output shaft from the front case by removing the 4 bolts with a 12mm socket. Remove the bearing retainer and snap ring.

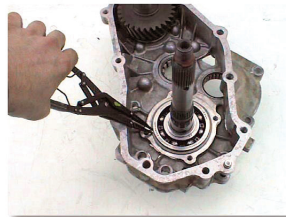

(21) Now that the roller bearing is removed, you will see a spacer. Remove the spacer, the gear and needle bearing.

**SPECIAL NOTE:** The components packaged in this kit have been assembled and machined for specific type of conversions. Modifications to any of the components will void any possible warranty or return privileges. If you do not fully understand modifications or changes that will be required to complete your conversion, we strongly recommend that you contact our sales department for more information. This instruction sheet is only to be used for the assembly of Advance Adapter components. We recommend that a service manual pertaining to your vehicle be obtained for specific torque values, wiring diagrams and other related equipment. These manuals are normally available at automotive dealerships and parts stores.

## TX2 CRAWLER ADAPTER TOYOTA 4WD TRUCKS 23T INPUT

The low gear and needle bearing must then be installed onto the new shaft supplied. The new thrust bushing and 1/4" ball will need to be placed on top of the output gear as illustrated.

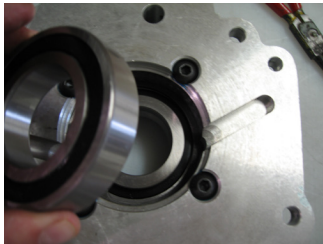

The first bearing is pressed in and retained with a snap ring. A thrust washer is placed on the bearing and the second bearing is pressed into the casting.

The new roller bearing will need to be installed into the adapter housing and retained by the snap ring provided. One of the thrust bushing gets placed in the housing and then the second bearing is then pressed into the adapter housing. We have also included a new caged needle bearing that needs to be installed into the adapter housing for the cluster gear support.

leave the new shaft assembly standing upright on the work bench and install the casting with the roller bearings on to the shaft assembly. The spacer washer between the bearing may need to be aligned with the bearing bores so as to allow the shaft to be slipped fully into the casting assembly. This shaft assembly is a light press fit. Once the shaft is installed through the bearings then install the small snap ring on the shaft. This snap ring will prevent the output shaft from traveling forward. Make sure the gear has the proper end play .007-.010".

The shift fork or shift rod for the reduction box must be modified. A key stock has been provided to be welded to the shifting component. This has to be done because this is the only shift rod retained in the crawler box.

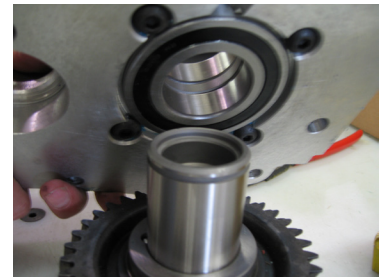

With the proper end play determined, the new shaft, gear, thrust bushings all in position & assembled into the new adapter, and the shifter modifications made, you can now assemble this assembly on the reduction gear box. Make sure that the new bearing has been installed for the counter shaft. Make sure that the shifter ring and fork are in the proper location and the pocket needle bearing is installed in the output shaft.



We have included 11 stud bolts, lock washers, flat washers, and nuts. Six (6) of these fasteners are for the front of the full transfer case and five (5) of them are for the crawler box.

The transfer case shift rod (circled) on the full transfer case should be shortened slightly to prevent any interference with the reduction gear box shifter rod. Cutting the chamfered portion off of this rod is normally sufficient.



**SPECIAL NOTE:** The components packaged in this kit have been assembled and machined for specific type of conversions. Modifications to any of the components will void any possible warranty or return privileges. If you do not fully understand modifications or changes that will be required to complete your conversion, we strongly recommend that you contact our sales department for more information. This instruction sheet is only to be used for the assembly of Advance Adapter components. We recommend that a service manual pertaining to your vehicle be obtained for specific torque values, wiring diagrams and other related equipment. These manuals are normally available at automotive dealerships and parts stores.

## TX2 CRAWLER ADAPTER TOYOTA 4WD TRUCKS 23T INPUT

### INSTALLATION OF THE GEAR BOX

When installing the additional reduction gear box into your Toyota truck, you will need to make sure that the truck is properly secured for transfer case removal. Once the vehicle is secured, both of the existing driveshafts will need to be removed along with the crossmember and transfer case. With the transfer case removed, the back side of the 5 speed transmission can then be inspected for the installation of the new reduction gear box. The output shaft should be 21 spline and should index perfectly into the Toyota reduction box. Make sure that the seal and the splines are properly fitted together.

With the new crawl box now in position, you can now assemble the transfer case back to the transmission and reduction box assembly. If the front driveshaft does not interfere, the original crossmember can remain in its original location. Vehicles with a 4" plus suspension lift or long front shackles will require some crossmember clearance modifications.

Lengthen the 4WD indicator light and install a new speedometer extension cable is necessary for this conversion. Install the shifter levers for both the transfer case and the reduction box, making the necessary modifications to the floorboard.

You will be required to lengthen the front driveshaft. If the truck is equipped with center support bearing on the rear driveshaft, remove it and lengthen the driveshaft. Otherwise, shorten it as required.

The new crawl box and transfer case gear oil should be one and the same. We do not require any seal between the two units. The same fill plug and oil level can be used.



**SPECIAL NOTE:** The components packaged in this kit have been assembled and machined for specific type of conversions. Modifications to any of the components will void any possible warranty or return privileges. If you do not fully understand modifications or changes that will be required to complete your conversion, we strongly recommend that you contact our sales department for more information. This instruction sheet is only to be used for the assembly of Advance Adapter components. We recommend that a service manual pertaining to your vehicle be obtained for specific torque values, wiring diagrams and other related equipment. These manuals are normally available at automotive dealerships and parts stores.

## TX2 CRAWLER ADAPTER TOYOTA 4WD TRUCKS 23T INPUT

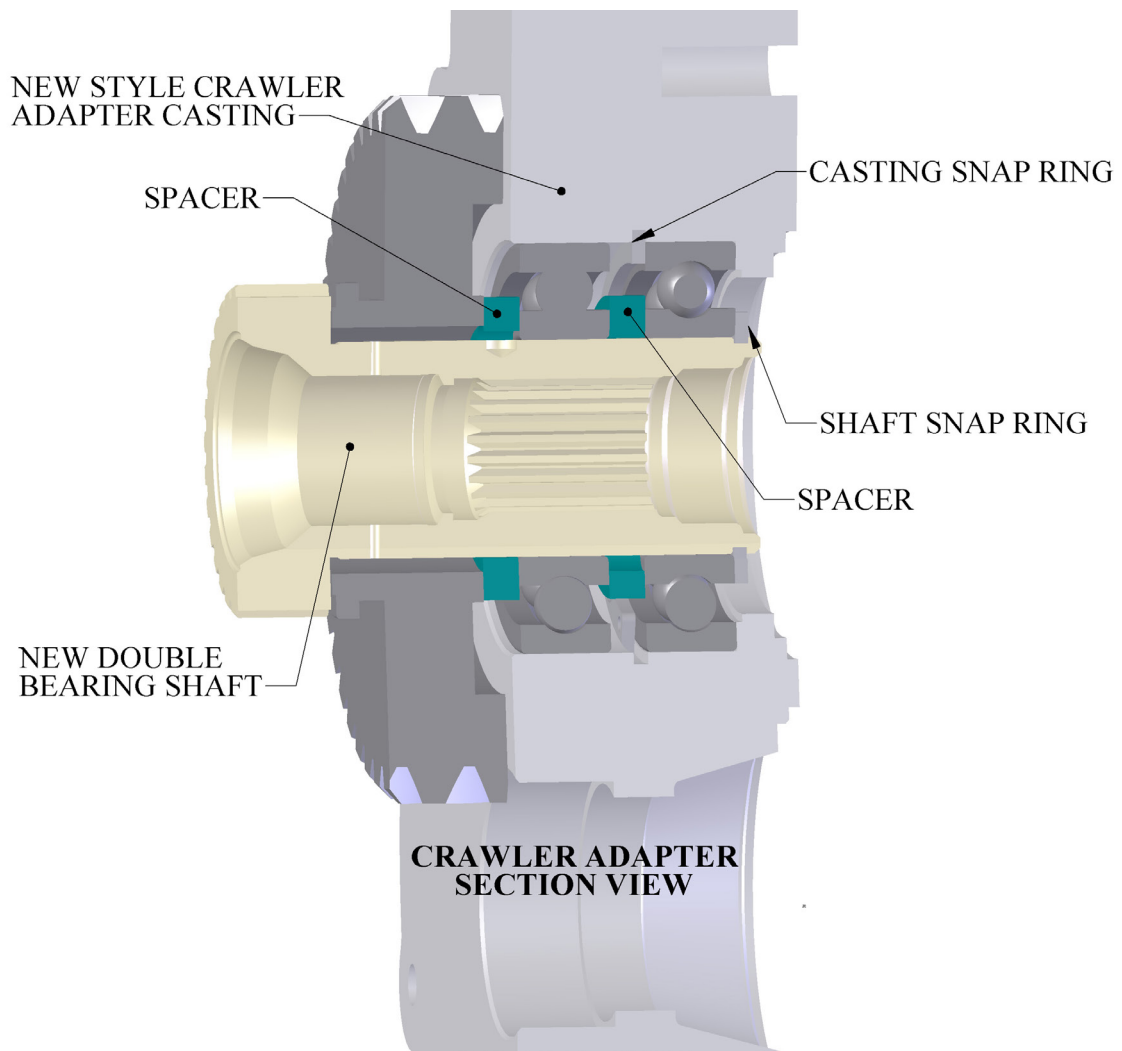

**SPECIAL NOTE:** The components packaged in this kit have been assembled and machined for specific type of conversions. Modifications to any of the components will void any possible warranty or return privileges. If you do not fully understand modifications or changes that will be required to complete your conversion, we strongly recommend that you contact our sales department for more information. This instruction sheet is only to be used for the assembly of Advance Adapter components. We recommend that a service manual pertaining to your vehicle be obtained for specific torque values, wiring diagrams and other related equipment. These manuals are normally available at automotive dealerships and parts stores.



## TX2 CRAWLER ADAPTER TOYOTA 4WD TRUCKS 23T INPUT

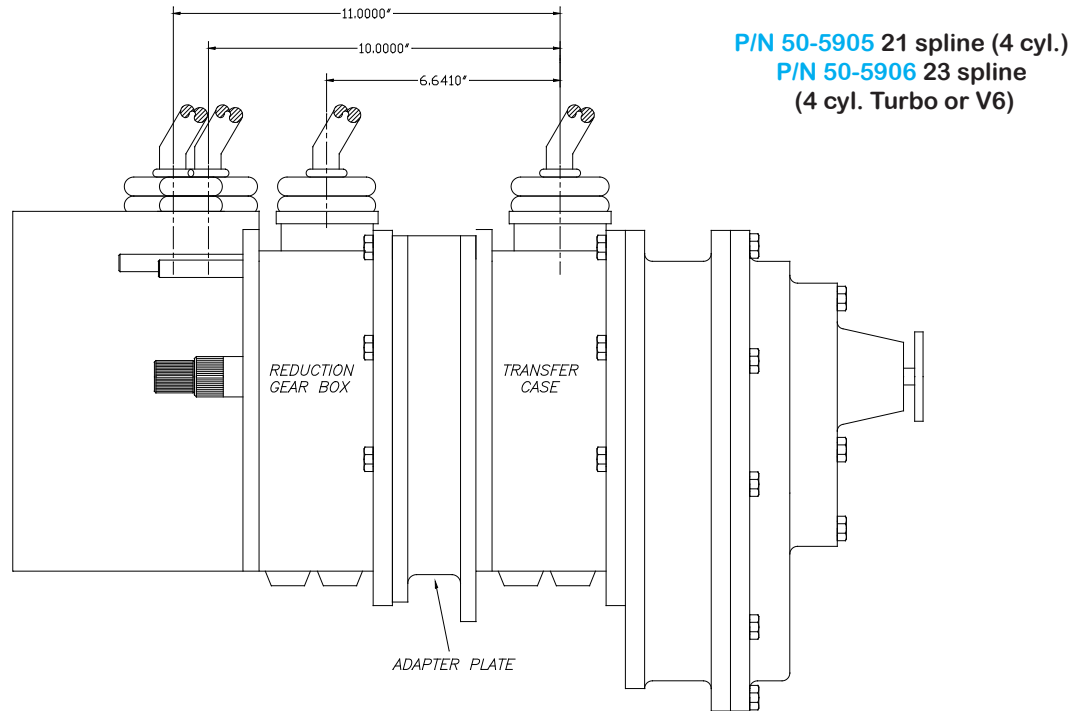

This chart covers the 4 cylinder Gear-Driven Transfer Case (7 bolt rear cover)

VEHICLE APPLICATION	TRANSFER CASE SHIFTER BASE LOCATION	DISTANCE
<b>79 to 83 Carburated 85 to 88 EFI</b>	Shifter on transfer case 4 Bolt Cast Iron Base 3-1/8" x 4-3/8"	<b>6 -1/2"</b>
<b>84 to 88 Carburated</b>	Shifter on transmission tailhousing 4 Bolt Aluminum Base 3-1/4" x 4"	<b>11"</b>
<b>86 to 87 EFI Turbo 89 to 95 EFI</b>	Shifter on transmission tailhousing 6 Bolt Aluminum Base Transfer case & transmission s shift handles are integral. Alum. base 4"x8"	<b>10"</b>

**Footnote #1 - The rear T/case must be a top shifting style (1979-83 Carbureted or 1985-88 EFI).**

**Footnote #2 - Reduction gear box can retain the original T/C shift rod location to match to the existing transmission, or the reduction box can be changed out to the 79-83 carbureted or 85-88 EFI box (T/C shift lever on reduction box).**

**Footnote #3 - Shift rods, forks & driveshaft flanges are interchangeable between all years shown.**